

VELO

Articolo: VELO54
Materiale: Flumood
Troppopieno: NO
Peso lordo: kg 6,7 ca.
Peso netto: kg 5,7 ca.

Descrizione: Lavabo ovale sopra piano in Flumood completo di piletta con scarico libero e raccordo per sifone. Verniciabile esternamente.

Article: VELO54
Material: Flumood
Overflow: NO
Gross weight: kg 6,7 ca.
Net weight: kg 5,7 ca.

Description: Oval top mount Flumood sink complete with drain pipe fitting and open plug, that can be lacquered externally.

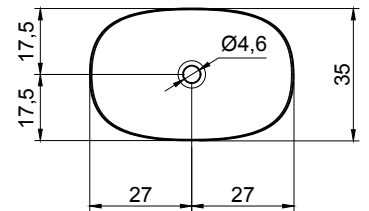
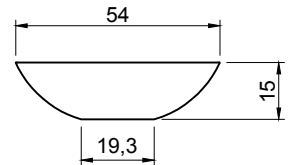
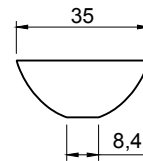

schema d' installazione lavabi e rubinetteria / sinks and taps installation layout

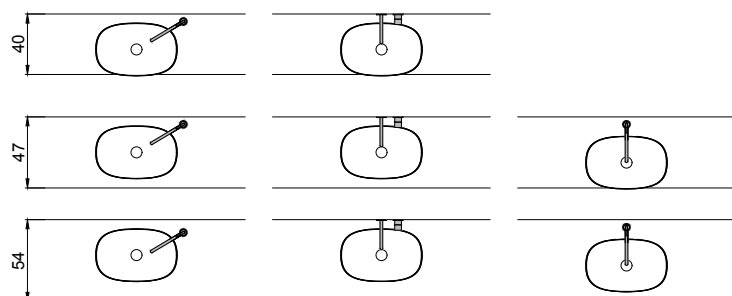

VELO

Articolo: VELO63
Materiale: Flumood
Troppopieno: NO
Peso lordo: kg 8 ca.
Peso netto: kg 7 ca.

Descrizione: Lavabo ovale sopra piano in Flumood completo di piletta con scarico libero e raccordo per sifone. Verniciabile esternamente.

Article: VELO63
Material: Flumood
Overflow: NO
Gross weight: kg 8 ca.
Net weight: kg 7 ca.

Description: Oval top mount Flumood sink complete with drain pipe fitting and open plug, that can be lacquered externally.

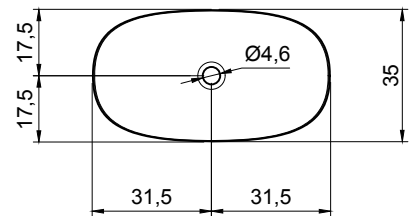
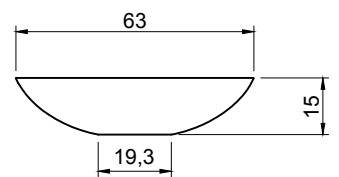
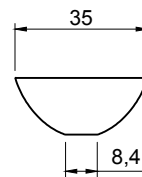

schema d' installazione lavabi e rubinetteria / sinks and taps installation layout

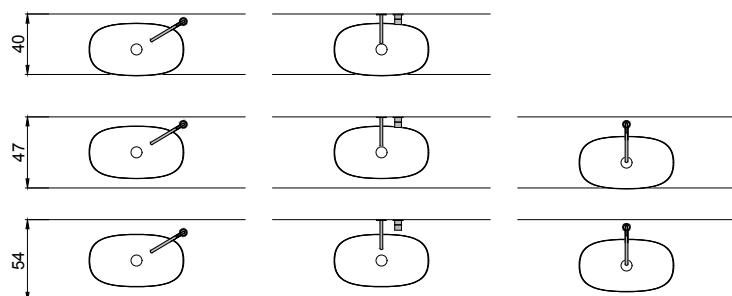

VELO

Articolo: **VELORETTO50**

Materiale: Flumood

Trooppieno: NO

Peso lordo: kg 10,5 ca.

Peso netto: kg 9,5 ca.

Descrizione: Lavabo rettangolare sopraiano in Flumood completo di piletta con scarico libero e raccordo per sifone. Verniciabile esternamente.

Article: **VELORETTO50**

Material: Flumood

Overflow: NO

Gross weight: kg 10,5 ca.

Net weight: kg 9,5 ca.

Description: Rectangular top mount Flumood sink complete with drain pipe fitting and open plug, that can be lacquered externally.

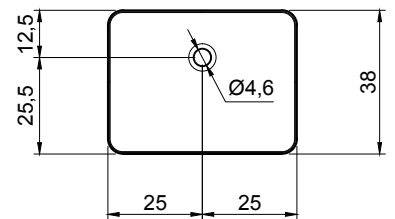
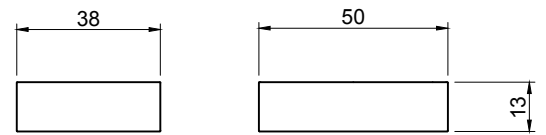

schema d' installazione lavabi e rubinetteria / sinks and taps installation layout

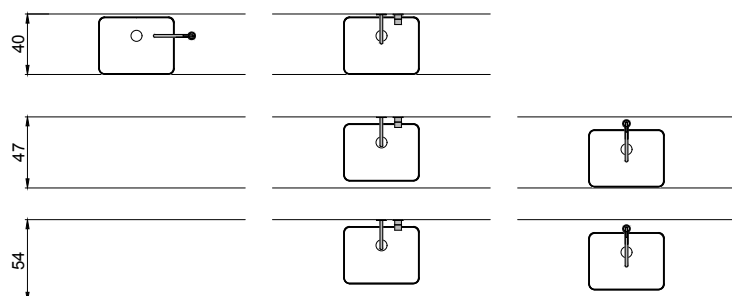

VELO

Articolo: **VELORETTO63**

Materiale: Flumood

Troppopieno: NO

Peso lordo: kg 13,1 ca.

Peso netto: kg 11,6 ca.

Dimensione imballo: cm 70 x 19 x 44

Descrizione: Lavabo rettangolare sopraiano in Flumood completo di piletta con scarico libero e raccordo per sifone. Verniciabile esternamente.

Article: **VELORETTO63**

Material: Flumood

Overflow: NO

Gross weight kg 13,1 ca.

Net weight: kg 11,6 ca.

Packing dimensions: cm 70 x 19 x 44

Description: Rectangular top mount Flumood sink complete with drain pipe fitting and open plug, that can be lacquered externally.

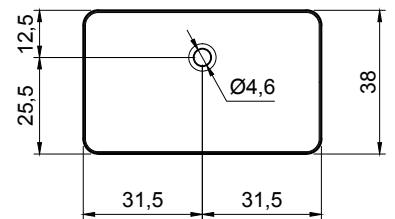
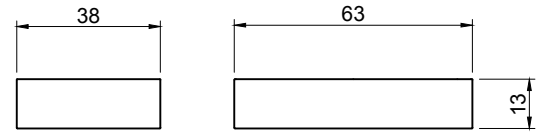

schema d' installazione lavabi e rubinetteria / sinks and taps installation layout

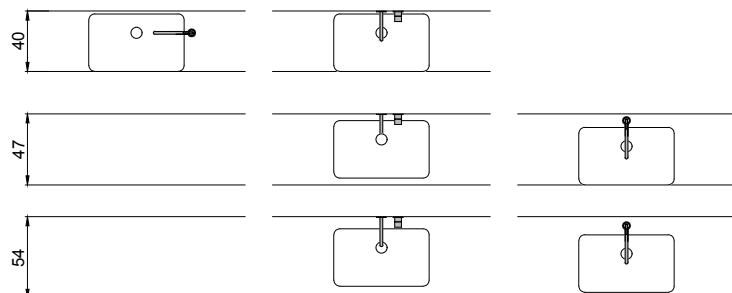

VELO

Articolo: **VELOTONDO45**

Materiale: Flumood

Troppo pieno: NO

Peso lordo: kg 6 ca.

Peso netto: kg 4,5 ca.

Dimensione imballo: cm 52 x 52 x 22

Descrizione: Lavabo tondo sopra piano in Flumood completo di piletta con scarico libero e raccordo per sifone. Verniciabile esternamente.

Article: **VELOTONDO45**

Material: Flumood

Overflow: NO

Gross weight: kg 6 ca.

Net weight: kg 4,5 ca.

Packing dimensions: cm 52 x 52 x 22

Description: Round top mount Flumood sink complete with drain pipe fitting and open plug, that can be lacquered externally.

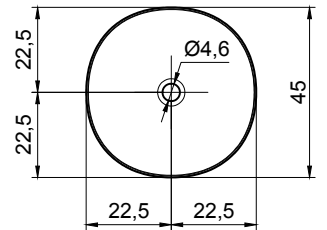
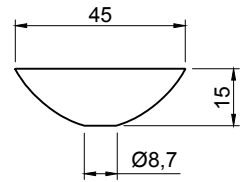

schema d'installazione lavabi e rubinetteria / sinks and taps installation layout

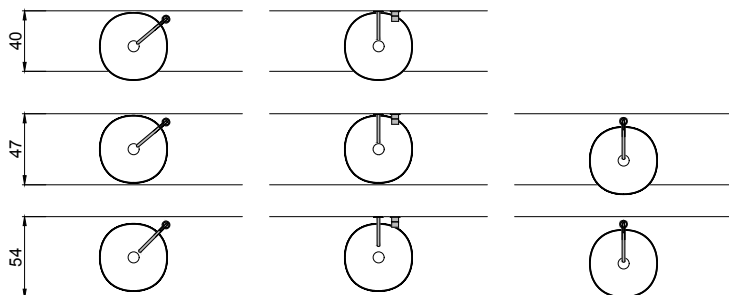

VELO

Articolo: **VELOTONDO54**

Materiale: Flumood

Troppopieno: NO

Peso lordo: kg 7,6 ca.

Peso netto: kg 6,6 ca.

Descrizione: Lavabo tondo sopra piano in Flumood completo di piletta con scarico libero e raccordo per sifone. Verniciabile esternamente.

Article: **VELOTONDO54**

Material: Flumood

Overflow: NO

Gross weight: kg 7,6 ca.

Net weight: kg 6,6 ca.

Description: Round top mount Flumood sink complete with drain pipe fitting and open plug, that can be lacquered externally.

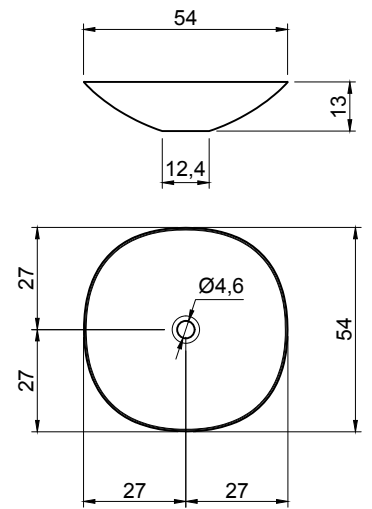

schema d'installazione lavabi e rubinetteria / sinks and taps installation layout



MATERIALI IMPIEGATI

FLUMOOD® è un materiale composto per la maggior parte da idrossido di alluminio e resine sintetiche a basso contenuto di stirene.

ISTRUZIONI PER L'USO E MANUTENZIONE

PULIZIA

Pulire con pulitori abrasivi. Per la pulizia è particolarmente consigliato il detergente liquido Art. CLEANSURFACE utilizzato con spugna abrasiva tipo SCOTCH BRITE®. Essendo un materiale omogeneo in tutto il suo spessore può venire ripristinato con spugnette e pulitori abrasivi attualmente in commercio, può quindi essere riparato dalle aggressioni superficiali, quali graffi, bruciature di sigaretta e macchie ostinate riportando la superficie alla bellezza originale. Per la finitura Texture si sconsiglia l'uso di spugne abrasive che potrebbero rovinare la superficie. Al termine della pulizia si consiglia di risciacquare abbondantemente.

ATOSSICITÀ

Il prodotto non risulta tossico o nocivo all'uomo, agli animali o all'ambiente.

ECOLOGIA

Alla fine della sua utilizzazione non disperdere l'oggetto nell'ambiente, ma smaltirlo secondo le modalità previste dall'azienda comunale di smaltimento rifiuti.

PRODUCT DESCRIPTION

FLUMOOD®

MATERIALS USED

FLUMOOD® is a material composed for the most part from aluminum hydroxide and synthetic resins with low styrene content

USAGE AND MAINTENANCE INSTRUCTIONS

CLEANING

Clean with abrasive cleaners. For cleaning it is particularly recommended the liquid detergent Art. CLEANSURFACE to be used with an abrasive sponge like SCOTCH BRITE®. For the Texture finish it is unadvisable to use abrasive sponges that could ruin the surface. After cleaning thoroughly rinse with water.

TOXICITY

The product does not appear to be toxic to humans, animals or environment.

ECOLOGY

Only discard in appropriate disposals as according to rules and regulations in your area.